

Basic DC Motor Circuits

Living with the Lab
Gerald Recktenwald
Portland State University
gerry@pdx.edu

DC Motor Learning Objectives

- Explain the role of a snubber diode
- Describe how PWM controls DC motor speed
- Implement a transistor circuit and Arduino program for PWM control of the DC motor
- Use a potentiometer as input to a program that controls fan speed

What is a snubber diode
and why should I care?

Simplest DC Motor Circuit

Connect the motor to a DC power supply

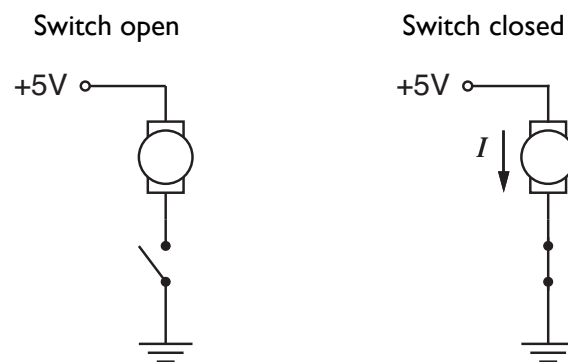

Current continues after switch is opened

Opening the switch does not immediately stop current in the motor windings.

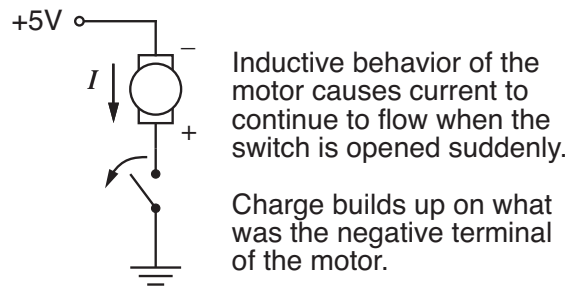

LWTL: DC Motor

5

Reverse current

Charge build-up can cause damage

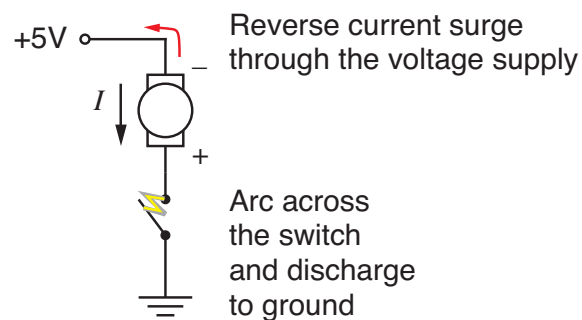

LWTL: DC Motor

6

Motor Model

Simple model of a DC motor:

- ❖ Windings have inductance and resistance
- ❖ Inductor stores electrical energy in the windings
- ❖ We need to provide a way to safely dissipate electrical energy when the switch is opened

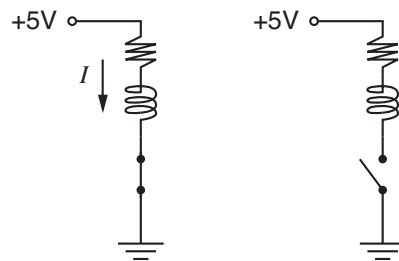

LWTL: DC Motor

7

Flyback diode or snubber diode

Adding a diode in parallel with the motor provides a path for dissipation of stored energy when the switch is opened

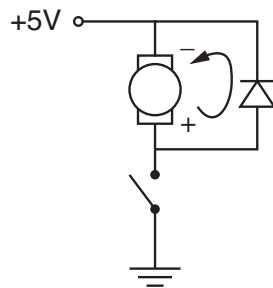

The flyback diode allows charge to dissipate without arcing across the switch, or without flowing back to ground through the +5V voltage supply.

LWTL: DC Motor

8

Pulse-width modulation (PWM) for DC motor speed control

Controlling DC Motor Speed

The voltage supplied to a DC motor controls its speed

Arduino cannot supply variable DC output

- ❖ Arduino lacks a true analog output
- ❖ Use Pulse-width modulation (PWM) to simulate a variable DC supply voltage
- ❖ PWM is a common technique for supplying variable power levels to “slow” electrical devices such as resistive loads, LEDs, and DC motors
- ❖ Arduino Uno has 6 PWM pins: Digital I/O pins 3, 5, 6, 9, 10, and 11

Arduino Uno has 6 PWM pins

Look for the ~ prefix on the digital pin label, e.g. ~3



LWTL: DC Motor

11

PWM: Pulsed with modulation

PWM simulates DC voltage control for *slow* loads

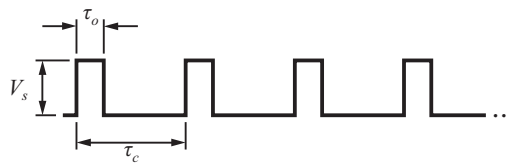

The effective voltage is $V_{\text{eff}} = V_s \frac{\tau_o}{\tau_c}$

$\frac{\tau_o}{\tau_c}$ is called the duty cycle

LWTL: DC Motor

12

Arduino PWM commands

Configure the output pin:

```
PWM_pin = ... ;          // one of 3, 5, 6, 9, 10, 11

void setup() {
  pinMode( PWM_pin, OUTPUT);
}
```

Set the duty cycle

```
void loop() {
  int duty_cycle = 150;    // between 0 and 255

  analogWrite( PWM_pin, duty_cycle );
}
```

The duty cycle is an 8 bit value:

$$0 \leq \text{duty_cycle} \leq 255$$

LWTL: DC Motor

13

Using a transistor to switch the load

Transistor as the switching device

- Each Arduino output channels has a 40 mA limit
- The maximum current draw for an Arduino is 200 mA
- Use Arduino as the brain
- Let another switching element be the brawn

Use an NPN Transistor as a switch

This device is designed for use as a medium power amplifier and switch requiring collector currents up to 500 mA



2N4401
TO-18



MMBT4401
SOT-23
Mark: 4X

NPN General Purpose Amplifier

The device is designed for use as a medium power amplifier and switch requiring collector currents up to 500 mA.

Absolute Maximum Ratings* <small>Ta = 25°C unless otherwise noted</small>			
Symbol	Parameter	Value	Units
V _{CE(s)}	Collector-Emitter Voltage	40	V
V _{CB(s)}	Collector-Base Voltage	60	V
V _{EB(s)}	Emitter-Base Voltage	6.0	V
I _C	Collector Current - Continuous	600	mA
T _{J, Tstg}	Operating and Storage Junction Temperature Range	-55 to +150	°C

*These ratings are limiting values above which the serviceability of any semiconductor device may be impaired.

NOTES:
1) These ratings are based on a maximum junction temperature of 150 degrees C.
2) These are steady state limits. The factory should be consulted on applications involving pulsed or the duty cycle operation.

Thermal Characteristics <small>Ta = 25°C unless otherwise noted</small>				
Symbol	Characteristic	Max		Units
		2N4401	MMBT4401	
P _D	Total Device Dissipation Derate above 25°C	625	300	mW
R _{θJC}	Thermal Resistance, Junction to Case	5.0	2.8	mW/°C
R _{θJA}	Thermal Resistance, Junction to Ambient	83.3	357	°C/W

*Data measured on FR-4 PCB 1.0" x 1.0" x 0.061"

2N4401 / MMBT4401

Electronic components in the fan kit

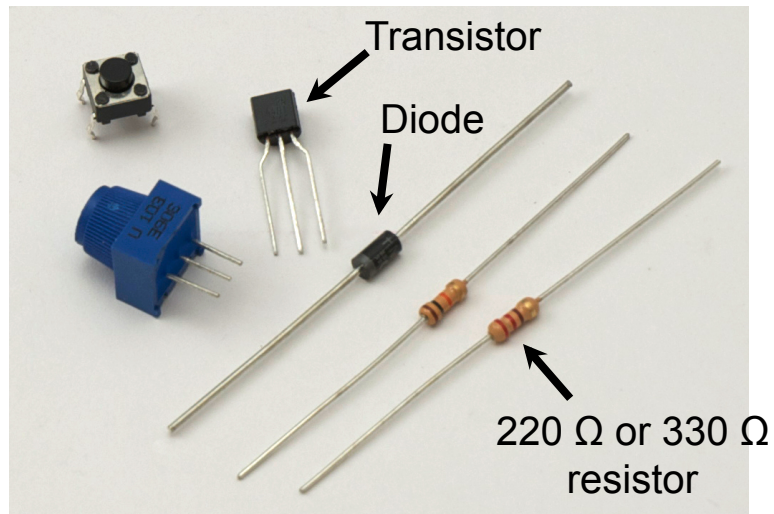

LWTL: DC Motor

17

Replace the Switch with a Transistor

A transistor allows on/off control to be automated and it allows switching of more current than an Arduino digital pin can supply.

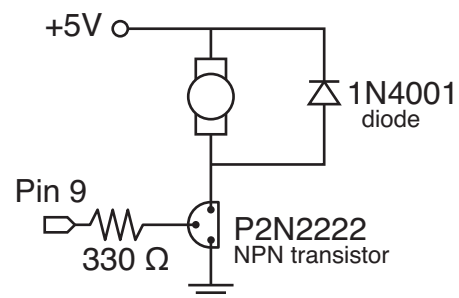

Pin 9 or another PWM pin drives the transistor base

LWTL: DC Motor

18

Alternative locations for the transistor

Moving the transistor (and any switch) between the power supply and the motor adds a bit of safety by tying the motor to ground when the system is idle

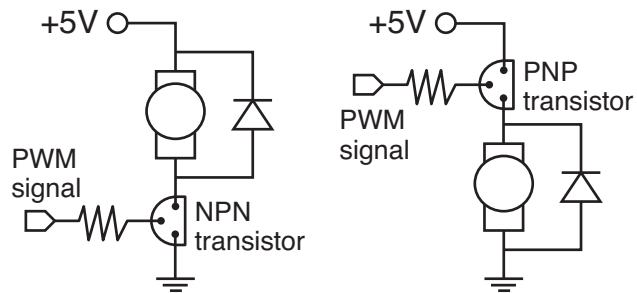

LWTL: DC Motor

19

Diode and transistor orientation

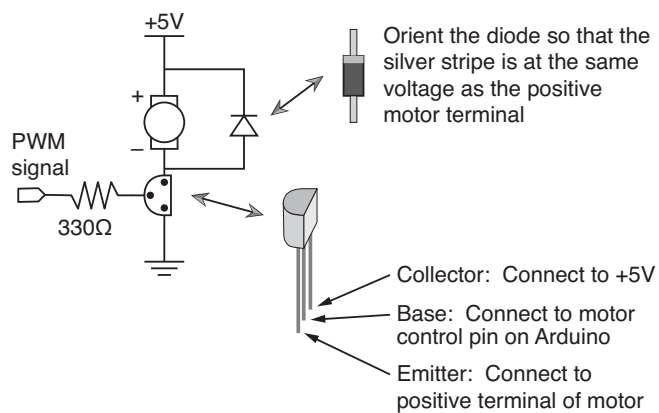

LWTL: DC Motor

20

Arduino Uno has 5 PWM pins

Look for the ~ prefix on the digital pin label, e.g. ~3

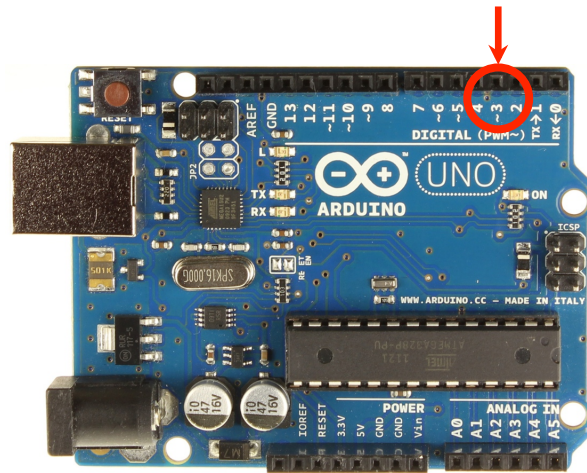

LWTL: DC Motor

21

DC Motor Circuit on tiny breadboard

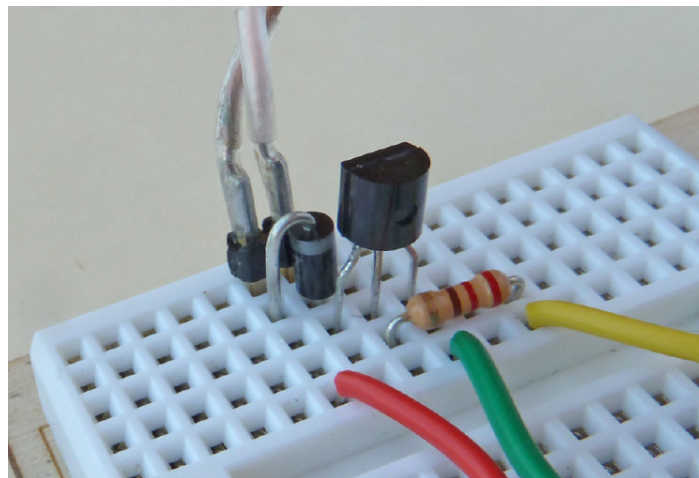

LWTL: DC Motor

22

+5V connections

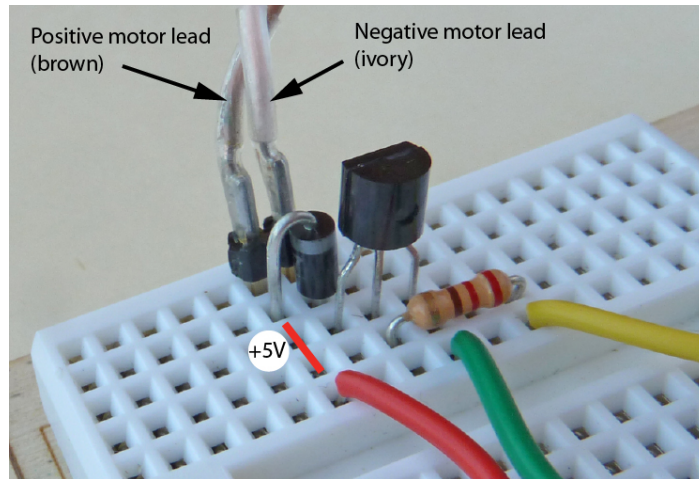

PWM signal is connected to transistor base

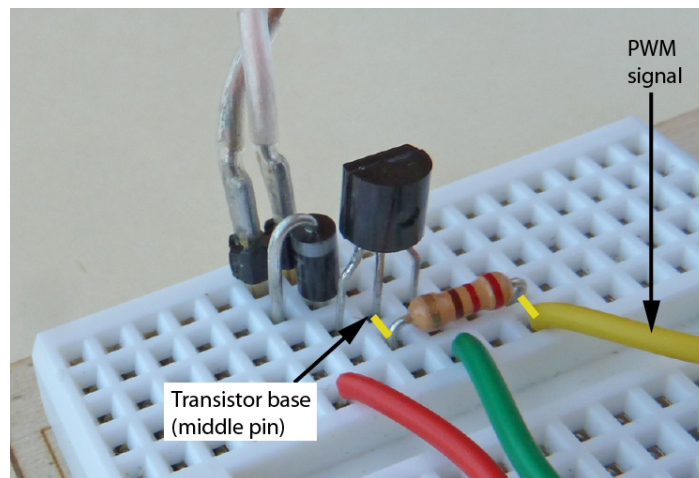

Arduino program to spin the DC Motor

Code is in spin_DC_motor.ino

```
// spin_DC_motor.ino Use PWM to control DC motor speed
int motorPin = 3; // Pin 3 has PWM, connected it to the DC motor

void setup() {
  pinMode(motorPin, OUTPUT); // Set motor pin to output mode
}

void loop() {
  analogWrite(motorPin, 150); // Motor at 150/255 of full speed
  delay(1000);
  analogWrite(motorPin, 250); // Motor at 250/255 of full speed
  delay(1000);
}
```

User input to control fan speed

Adjust fan speed with potentiometer input

Use the potentiometer circuit from the earlier analog input exercise

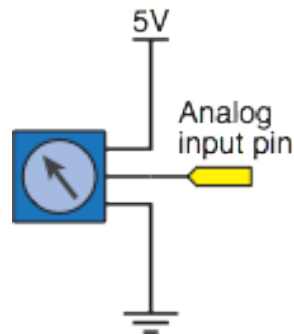
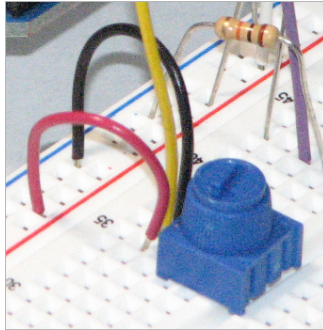

LWTL: DC Motor

27

Adjust fan speed with potentiometer input

Code is in DC_motor_speed_control.ino

```
// File: DC_motor_speed_control.pde
//
// Use potentiometer input to set the speed of a DC motor
// Output to the motor is PWM

int motorPin = 3; // pin connected to the DC motor
int potPin = 1; // analog input connected to the potentiometer

void setup()
{
  pinMode(motorPin, OUTPUT);
}

void loop()
{
  int PWMoutput, potReading;

  potReading = analogRead(potPin);
  PWMoutput = map(potReading, 0, 1023, 0, 255 );
  analogWrite(motorPin, PWMoutput);
}
```

LWTL: DC Motor

28

Adjust fan speed with potentiometer input

```
void loop() {  
  int PWMoutput, potReading;  
  
  potReading = analogRead(potPin);  
  PWMoutput = map(potReading, 0, 1023, 0, 255 );  
  analogWrite(motorPin, PWMoutput);  
}
```

Each time through the loop:

- ❖ Read the voltage at the potentiometer wiper
 - ▶ Input value is a 10-bit integer: $0 \leq \text{potReading} \leq 1023$
- ❖ Scale the 10-bit value (max 1023) to an 8-bit value (max 255)
 - ▶ `PWMoutput = map(potReading, 0, 1023, 0, 255);`

range for
potReading

range for
PWMoutput
- ❖ Update the PWM signal
 - ▶ `analogWrite(motorPin, PWMoutput);`